

# Panasonic®

## Installation Guide

---

Home Network System  
Outdoor Camera

Model No. **KX-HNC600**



**Thank you for purchasing a Panasonic product.**

This document explains how to install the outdoor camera properly.  
For details about how to use the system, refer to the User's Guide (page 26).

Please read this document before using the unit and save it for future reference.  
For assistance, visit our Web site: **[www.panasonic.com/support](http://www.panasonic.com/support)**  
for customers in the U.S.A. or Puerto Rico.

**Please register your product: [www.panasonic.com/prodreg](http://www.panasonic.com/prodreg)**

Printed in China

## Table of Contents

---

### Introduction

Accessory information .....	3
-----------------------------	---

### Important Information

About this system .....	4
For your safety .....	4
Important safety instructions .....	5
For best performance .....	5
Privacy and rights of portrait .....	6
Other information .....	6

### Installation Location

Wireless communication range .....	8
Information about sensor features .....	8
Installation location examples .....	11
Do not install in these locations .....	13

### Setup

Part names and functions .....	15
LED indicator .....	15
Setup overview .....	15
Registering the camera .....	16
Confirming the registration area .....	16
Installation .....	17

### Appendix

Testing the motion detection range .....	22
Adjusting the infrared sensor range .....	22
Features available when using the [Home Network] app .....	26
Accessing the User's Guide .....	26
Specifications .....	27
FCC and other information .....	28
Customer services .....	29
Warranty (For United States and Puerto Rico) .....	30

## Accessory information

### Supplied accessories

No.	Accessory item/Part number	Quantity
①	AC adaptor/PNLV2360Z	1
②	Camera mounting stand/PNZB1002Z	1
③	Wall mounting screws (25 mm (1 inch))/XTB4+25AVW	4
④	Suspension wire tool – Safety wire: 1 PQME10080Z – Washers: 2 Small washer for attaching safety wire to camera $\phi$ 12 mm (15/32 inches)/XWG26D12VW Large washer for attaching safety wire to wall $\phi$ 16 mm (5/8 inches)/XWG4F16VW – Screws: 2 Small screw for attaching safety wire to camera 10 mm (3/8 inches)/XTB26+10GVW Large screw for attaching safety wire to wall 25 mm (1 inch)/XTB4+25AVW	1
⑤	Sensor range cap/PNHG1210Z	1



### Other information

- Design and specifications are subject to change without notice.
- The illustrations in these instructions may vary slightly from the actual product.

### Trademarks

- microSDHC is a trademark of SD-3C, LLC.
- iPhone and iPad are registered trademarks of Apple Inc.
- Android is a trademark of Google Inc.
- All other trademarks identified herein are the property of their respective owners.

### Notice

- The hub supports microSD and microSDHC memory cards. In this document, the term “microSD card” is used as a generic term for any of the supported cards.

## Important Information

---

### About this system

This system is an auxiliary system; it is not designed to provide complete protection from property loss. Panasonic will not be held responsible in the event that property loss occurs while this system is in operation.

### For your safety

To prevent severe injury and loss of life/property, read this section carefully before using the product to ensure proper and safe operation of your product.

#### **WARNING**

#### Power connection

- Use only the power source marked on the product.
- Do not overload power outlets and extension cords. This can result in the risk of fire or electric shock.
- Completely insert the AC adaptor/power plug into the power outlet. Failure to do so may cause electric shock and/or excessive heat resulting in a fire.
- Regularly remove any dust, etc. from the AC adaptor/power plug by pulling it from the power outlet, then wiping with a dry cloth. Accumulated dust may cause an insulation defect from moisture, etc. resulting in a fire.
- Unplug the product from power outlets if it emits smoke, an abnormal smell, or makes an unusual noise. These conditions can cause fire or electric shock. Confirm that smoke has stopped emitting and contact us at [www.panasonic.com/contactinfo](http://www.panasonic.com/contactinfo)
- Unplug from power outlets and never touch the inside of the product if its casing has been broken open. Danger of electric shock exists.
- Never touch the plug with wet hands. Danger of electric shock exists.
- Do not connect non-specified devices.
- When opening holes in walls for installation or wiring, or when securing the power cord,

make sure you do not damage existing wiring and ductwork.

- Do not leave the power cable exposed outdoors.

#### Installation

- To prevent the risk of fire or electrical shock, do not expose the product to rain or any type of moisture.
- Do not place or use this product near automatically controlled devices such as automatic doors and fire alarms. Radio waves emitted from this product may cause such devices to malfunction resulting in an accident.
- Do not allow the power cord to be excessively pulled, bent or placed under heavy objects.
- Do not mount the bracket in an unstable location, in a location subject to frequent vibration, on a ceiling, or on a weak wall. (Do not mount on gypsum board, concrete blocks, wooden materials exposed to the outdoors, walls with very rough surfaces, or surfaces that are narrower than the width of the wall mount bracket.) There is a risk of injury if the product falls, or of fire or electric shock if water enters the product.
- Keep small parts (microSD cards, screws, washers, sensor range caps, etc.) out of the reach of children. There is a risk of swallowing. In the event they are swallowed, seek medical advice immediately.

#### Operating safeguards

- Unplug the product from power outlets before cleaning. Do not use liquid or aerosol cleaners.
- Do not disassemble the product.
- Keep the sensor range caps out of the reach of children. There is a risk of swallowing. In the event they are swallowed, seek medical advice immediately.
- Never put metal objects inside the product. If metal objects enter the product, turn off the circuit breaker and contact an authorized service center.

### Medical

- Consult the manufacturer of any personal medical devices, such as pacemakers or hearing aids, to determine if they are adequately shielded from external RF (radio frequency) energy. DECT features operate between 1.92 GHz and 1.93 GHz with a peak transmission power of 115 mWV.
- Do not use the product in health care facilities if any regulations posted in the area instruct you not to do so. Hospitals or health care facilities may be using equipment that could be sensitive to external RF energy.

### CAUTION

#### Installation and location

- Never install wiring during a lightning storm.
- Although this product conforms to the IPX5\* code, do not intentionally expose it to water. \*IPX5 indicates that the product is protected against water jets: water projected at all angles through a 6.3 mm nozzle flow rate of 12.5 liters/minute at a pressure of 30 kN/m<sup>2</sup> for 3 minutes from a distance of 3 meters.
- The AC adaptor is used as the main disconnect device. Ensure that the AC outlet is installed near the product and is easily accessible.
- If the wiring is underground, do not make any connections underground.
- If the wiring is underground, make sure the power cable and other wiring is properly waterproofed by running the cables through a conduit.

#### Preventing accidents and injuries

- The safety wire must be used when mounting the product. There is a risk of injury if the product falls.
- Do not put your ear(s) near the speaker, as loud sounds emitted from the speaker may cause hearing impairment.
- Do not look directly at the LED lights when they are lit. Failure to do so may cause damage to eyes.

### Important safety instructions

When using your product, basic safety precautions should always be followed to reduce the risk of fire, electric shock, and injury to persons, including the following:

1. Do not use this product near water for example, near a bathtub, washbowl, kitchen sink, or laundry tub, in a wet basement or near a swimming pool.
2. Use only the power cord indicated in this document.

#### SAVE THESE INSTRUCTIONS

### For best performance

#### Hub location/avoiding noise

The hub and other compatible Panasonic devices use radio waves to communicate with each other.

- For maximum coverage and noise-free communications, place your hub:
  - at a convenient, high, and central location with no obstructions between the product and hub in an indoor environment.
  - away from electronic appliances such as TVs, radios, personal computers, wireless devices, or other phones.
  - facing away from radio frequency transmitters, such as external antennas of mobile phone cell stations. (Avoid putting the hub on a bay window or near a window.)
- If the reception for a hub location is not satisfactory, move the hub to another location for better reception.

#### Environment

- Keep the product away from electrical noise generating devices, such as fluorescent lamps and motors.
- The product should be kept free from excessive smoke, dust, high temperature, and vibration.

## Important Information

---

- Do not expose this product to direct sunlight or other forms of powerful light such as halogen lights for long periods of time. (This may damage the image sensor.)
- Do not place heavy objects on top of the product.
- When you leave the product unused for a long period of time, unplug the product from the power outlet.
- The product should be kept away from heat sources such as heaters, kitchen stoves, etc. It should not be placed in rooms where the temperature is less than -20 °C (-4 °F) or greater than 50 °C (122 °F). Damp basements should also be avoided.
- Do not allow the lens cover or the infrared sensor to become scratched or dirty. (This may cause image quality to be reduced, incorrect detections, malfunctions, or damage to the lens cover and infrared sensor.)
- Operating the product near electrical appliances may cause interference. Move away from the electrical appliances.

---

## Privacy and rights of portrait

When installing or using the camera, please take into consideration the rights of others with regard to privacy.

It is generally said that "privacy" means the ability of an individual or group to stop information about themselves from becoming known to people other than those whom they choose to give the information. "Rights of portrait" means the right to be safe from having your own image taken and used indiscriminately without consent.

---

## Other information

### Routine care

- To prevent incorrect detections, unplug the product before performing routine care.
- Wipe the outer surface of the product with a soft moist cloth.

- Do not use benzene, thinner, or any abrasive powder.
- Do not apply running water to the product.

---

## Camera image quality

- Camera images may have the following characteristics.
  - Colors in images may differ from the actual colors.
  - When there is light behind the subject (i.e., backlighting), faces may appear dark.
  - Image quality may be reduced in dark locations.
  - Images may appear hazy when there are outdoor lights in use.

---

## Protecting your recordings

- Do not remove the microSD card or disconnect the hub's AC adaptor while reading or writing data to the microSD card. Data on the card could become corrupted.
- If a microSD card malfunctions or is exposed to electromagnetic waves or static electricity, data on the card could become corrupted or erased. Therefore we recommend backing up important data to a computer or other device.

### Notice

- This product is designed for use in the United States of America. Sale or use of this product in other countries may violate local laws.
- Cet appareil est conçu pour être utilisé aux États-Unis d'Amérique. La vente ou l'emploi de cet appareil dans certains autres pays peut constituer une infraction à la législation locale.
- Este producto está diseñado para usarse en los Estados Unidos de América. La venta o el empleo de este producto en ciertos países puede constituir violación de la legislación local.
- 本產品專為美國使用而設。若在其他國家銷售或使用，可能會違反當地法例。
- この製品は、日本国外での使用を目的として設計されており、日本国内での使用は法律違反となります。従って、当社では日本国内においては原則として修理などのサービスは致しかねます。

## Installation Location

---

### Wireless communication range

The wireless communication range of each device in the system from the hub is approximately 50 m (160 feet) indoors and approximately 300 m (1,000 feet) outdoors. Wireless communication may be unreliable when the following obstacles are located between the hub and other devices.

- Metal doors or screens
- Walls containing aluminum-sheet insulation
- Walls made of concrete or corrugated iron
- Double-pane glass windows
- Multiple walls
- When using each device on separate floors or in different buildings

**Note:**

- The camera's LED indicator blinks quickly in red if it is out of range of the hub. In this case, confirm all connections, including those of the hub.

---

### Information about sensor features

The camera has 2 sensor features that are used for motion detection: a visual sensor and an infrared sensor (i.e., heat sensor).

Please read the following information before deciding where to install the camera.

**Note:**

- The camera's sensor features are not designed to be used in situations that require high reliability. We do not recommend use of the sensor features in these situations.
- Panasonic takes no responsibility for any injury or damage caused by the use of the camera's sensor features.

---

### Detection method

Visual sensor	Infrared sensor
The camera detects changes in the images being displayed. <ul style="list-style-type: none"><li>● The camera detects changes in the brightness levels of moving objects.</li></ul>	The camera detects temperature differences of objects in the images being displayed. <ul style="list-style-type: none"><li>● The infrared sensor uses infrared rays to detect temperature differences within its range that are emitted naturally by people, animals, etc.</li></ul>

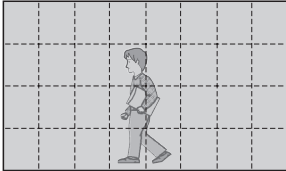
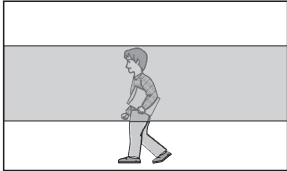

### Detection range

Visual sensor	Infrared sensor
<p>Can detect motion anywhere in the visible image.</p>  <p>The diagram shows a person walking from left to right across a grid of dashed lines. The grid covers the entire visible area, indicating that the visual sensor can detect motion anywhere within that range.</p> <ul style="list-style-type: none"> <li>You can adjust the area detectable by the visual sensor. For more information, refer to the User's Guide (page 26).</li> </ul>	<p>Can detect motion only in part of the visible image (shown here in gray)</p>  <p>The diagram shows a person walking from left to right across a horizontal band that is shaded gray. This shaded band represents the limited detection range of the infrared sensor.</p> <ul style="list-style-type: none"> <li>You can adjust the area detectable by the infrared sensor. See "Adjusting the infrared sensor range", page 22.</li> <li>Detection does not occur when there are obstacles in front of the infrared sensor. Remove the obstacles or change the installation location.</li> </ul>

### Main characteristics

Visual sensor	Infrared sensor
<p>Easily detects movement in the daytime or when it is bright.</p> <ul style="list-style-type: none"> <li>Movement may be incorrectly detected when the moving object and the background have a similar color.</li> <li>Movement may be incorrectly detected when there are sudden changes to the overall brightness levels such as when external lights are used.</li> </ul>	<p>Easily detects when there is a big difference between the temperatures of objects and the surrounding environment, such as in winter or late at night.</p> <ul style="list-style-type: none"> <li>The sensor cannot easily detect when there is no difference between the temperatures of objects and the surrounding environment, such as in summer or during the daytime.</li> <li>If the camera is mounted facing a road, the sensor may detect incorrectly due to interference caused by the heat from passing cars.</li> </ul>

## Installation Location

---

### Direction of motion

It is easier to detect objects that move sideways in front of the camera, and more difficult to detect objects that move directly toward the front of the camera.

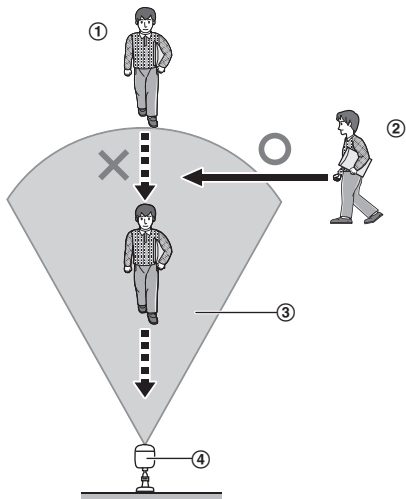

- ① It is difficult to detect movement directly towards the front of the camera.
- ② It is easy to detect movement sideways in front of the camera.
- ③ Detection range
- ④ Camera

## Installation location examples

### I want to detect visitors approaching the house

Refer to the table below for detecting visitors at an entrance or gate without detecting cars in the street.

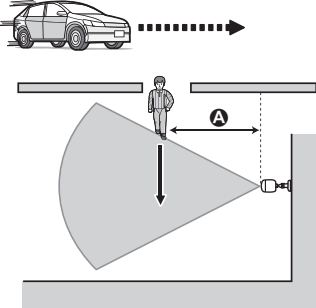
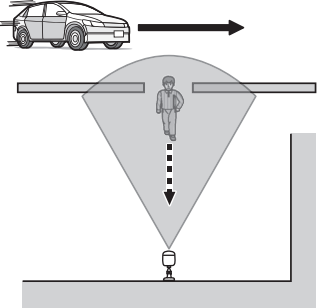
Ideal example	Poor example
 <p><b>A</b> Approx. 3 m (9.8 feet) Visitors pass in front of the camera from side to side, cars in the street are less likely to cause false detections.</p>	 <p>Cars in the street are more likely to cause false detections.</p>

## Installation Location

### I want to detect people entering the garage without detecting cars in the street.

Refer to the table below for detecting people entering a garage without detecting cars in the street.

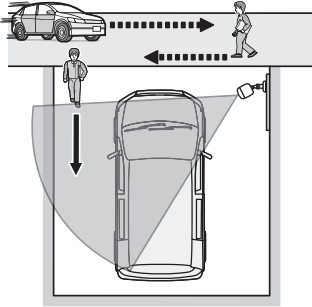
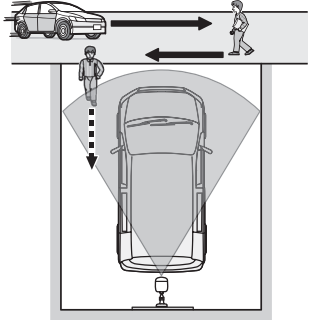
Ideal example	Poor example
 <p data-bbox="106 599 497 665">Visitors pass in front of the camera from side to side, cars in the street are less likely to cause false detections.</p> <ul data-bbox="106 666 497 733" style="list-style-type: none"><li>● To prevent faces from being obscured by tall vehicles, adjust the installation position and angle of the camera.</li></ul>	 <p data-bbox="526 613 890 658">Cars in the street are more likely to cause false detections.</p>

## Do not install in these locations

### Installing in the following areas may cause deformation, discoloration, malfunction, or operational failure

- In direct sunlight or directly under an outdoor light (even if the surroundings are within operational temperature range, parts of the product may become hot)
- Areas subject to frequent vibration, shock, or impact
- Near fire, heating devices, magnetic fields (such as near magnets), or air conditioners (including outdoor equipment such as unit compressors)
- Areas exposed to grease or steam
- Near devices that emit strong radio waves, such as mobile phones
- Areas subject to extreme temperature changes (which can lead to condensation)
- Near coasts directly subjected to sea breezes, or near sulfuric hot springs (exposure to salt can shorten the life of the product)
- Near TVs, radios, automated office equipment such as computers, air conditioners, water heater panels (with intercom), or home security equipment (these may cause noise)
- Near satellite broadcasting receivers such as tuners, TVs with built-in satellite tuners, and recorders (broadcasted images may be distorted)
- Areas where hydrogen sulfide, ammonia, dust, or toxic gases are present

### Installing in the following areas may cause false detections

- Areas where people approach directly from the front of the camera, such as narrow walkways

- **A** Camera
- **B** Difficult to detect

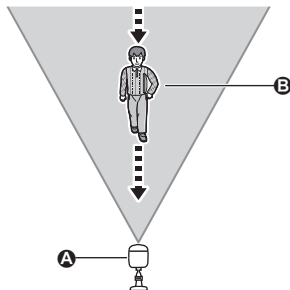

- Areas where objects such as trees or hanging laundry move due to wind (temperature variation and motion may cause false detections)

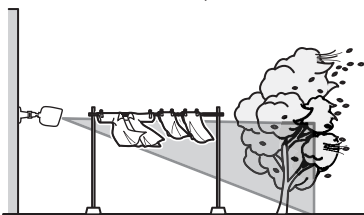

- On roads with high traffic (passing cars may cause sensor detections even if they are 5 m (16.4 feet) or more away)

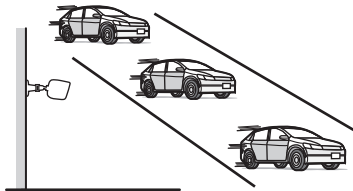

## Installation Location

---

- Areas affected by breezes from fans, air conditioning unit compressors, water heaters, or car exhaust (severe temperature variations may cause false detections)

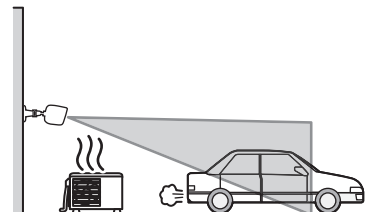

- Areas with strong winds (wind can shake the camera and cause false motion detection)
- Areas with reflective objects, such as glass, that can interfere with detection of temperature variation
- Areas where brightness changes easily (such as areas where shadows form in the afternoon and lights turn on at night)
- Areas where backlight occurs (faces appear dark and are difficult to identify), such as the following
  - Areas where most of the background is the sky
  - Areas where direct sunlight reflects off a white wall or background
  - Bright areas such as those exposed to direct sunlight

## Part names and functions

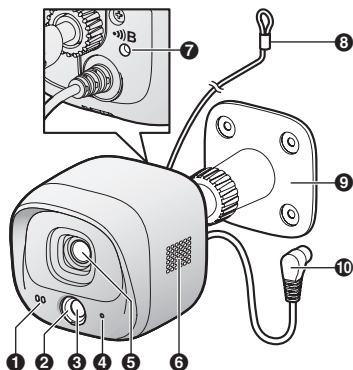

- 1 Microphone
- 2 Sensor range cap (Standard)
- 3 Infrared sensor
- 4 LED indicator
- 5 Lens unit
- 6 Speaker
- 7 **[•••]B**  
Used when registering the camera to the hub.
- 8 Safety wire
- 9 Camera mounting stand
- 10 DC cable

## LED indicator

You can use the LED indicator to confirm the camera's status.

Indicator	Status
Off	No power, or LED indicator is turned off*1
Green, lit	Normal operation*1
Green, blinking	Registration mode
Red	Motion detection features were triggered

Indicator	Status
Red, blinking	Live images are being viewed or recorded
Red, blinking quickly	Camera is out of range of the hub, or device malfunction
Amber, blinking	Camera is not registered to a hub

- \*1 You can configure the camera so that its LED indicator does not light during normal operation. For more information, refer to the User's Guide (page 26).

## Setup overview

- 1 **Initial setup**  
Make sure you can access the system using your mobile device. For details, refer to the System Setup Guide included with your hub.
- 2 **Registration**  
Required only if the camera was purchased separately (i.e., not as part of a bundle).
- 3 **Confirm the installation area**  
Read the information in this document to confirm that the desired installation area is suitable to proper operation.
- 4 **Installation**  
Install the camera in the desired location and connect the camera to the power outlet.
- 5 **Adjust the infrared sensor range**  
Confirm the sensor range area and adjust it if necessary using the included sensor range adjustment caps.

### Registering the camera

This procedure is not required for devices that were included as part of a bundle.

Before you can use the camera, it must be registered to the hub.

If the camera is not registered to a hub, the camera's LED indicator blinks in amber.

You can register each device by using the registration buttons or the **[Home Network]** app.

**Note:**

- Before registering the camera, make sure the AC adaptors of the hub and camera are connected and each device is powered.

### Using registration buttons

**1 Hub:**

Press and hold **[••]B CAMERA** until the LED indicator blinks in green.

**2 Camera:**

Using an object with a thin tip, press and hold **[••]B** until the LED indicator blinks in green (page 15).

- When registration is complete, the hub sounds one long beep.

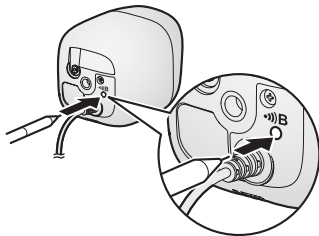

**Note:**

- To cancel the registration, press the registration button on the hub and on the camera.
- If registration fails, the hub sounds several short beeps.

### Using the app

When you register the camera by using the **[Home Network]** app, you can assign a name to your devices and group them by location. For more information, refer to the User's Guide (page 26).

### Confirming the registration area

Before deciding where to install the camera, carefully read the chapter "Installation Location", beginning on page 8, to confirm the installation location and direction.



## Installation

### Installation precautions

- Do not install the camera on a ceiling.
- Do not install the camera in areas directly exposed to water or rain.
- Holes must be made in the wall for cables and wires to pass through. Panasonic takes no responsibility for issues related to opening holes in walls.
- Make sure to waterproof the holes you make in the wall.
- Make sure you attach the safety wire to prevent the camera from falling.
- Do not use an impact driver. (This may lead to damaged screws or over-tightening.)
- Mount the camera on the stable location where the unit can be adequately supported when installing.
- The AC adaptor should be connected to a vertically oriented or floor-mounted AC outlet. Do not connect the AC adaptor to a ceiling-mounted AC outlet, as the weight of the adaptor may cause it to become disconnected.
- Do not mount the camera on a soft material. It may fall down, break or cause injury.

## Wall material information

### Siding

- Use the included screws  $\varnothing 4 \text{ mm} \times 25 \text{ mm}$  ( $\varnothing 5/32 \text{ inches} \times 1 \text{ inch}$ ). Make sure the pull-out capacity of each screw is at least 294 N (30 kgf).
- If the weight of the camera is supported by the siding only, the siding could become damaged. Make sure you mount the camera in a location where the structure behind the siding can be used to support the weight of the camera. If this is not possible due to the thickness of the siding, use commercially-available screws  $\varnothing 4 \text{ mm} \times$  longer than 25 mm ( $\varnothing 5/32 \text{ inches} \times$  longer than 1 inch).
- Drill a pilot hole using a drill bit that is appropriate for the type of siding. Remove any debris after drilling the pilot hole. Do not drill the pilot hole into the structure behind the siding.

### Poor example

No support behind exterior surface

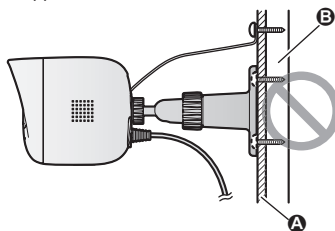

- A** Siding
- B** Open space, no support

## Setup

### Ideal example

Structure supports exterior surface

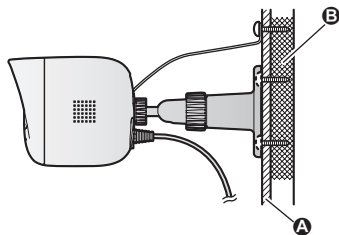

**A** Siding

**B** Structure behind siding

### Concrete

- Do not use the included screws. Use screw anchors (screw  $\varnothing$ : 4 mm (5/32 inches)) designed for concrete walls.
- Carefully read the instructions supplied with the anchors. Follow instructions regarding drill bit diameter, hole depth, etc.
- Drill a pilot hole. Remove any debris after drilling the pilot hole.

- 1 Mark the hole depth on the drill bit (**A**) and then drill a pilot hole.

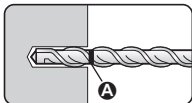

- 2 Remove debris.

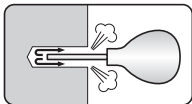

- 3 Insert an anchor, tighten the screw, then remove the screw to secure the anchor.

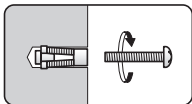

- 4 Insert the screw and tighten it.

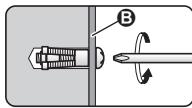

**B** Camera mounting stand

### ALC (autoclaved lightweight cellular concrete)

- Depending on the type of ALC panel, you may not be able to attach the camera. Consult the ALC panel manufacturer.
- Do not use the included screws. After consulting the manufacturer of the ALC panel, use only commercially-available metal screw anchors (screw  $\varnothing$ : 4 mm (5/32 inches)) designed for ALC panels.
- Carefully read the instructions supplied with the anchors. Follow instructions regarding drill bit diameter, hole depth, etc.
- Drill a pilot hole. Remove any debris after drilling the pilot hole.
- Seal the pilot hole with a commercially-available waterproof sealant.

### Other materials (mortar, tile, etc.)

- Do not use the included screws.
- Consult the builder or licensed professional regarding the type of anchor appropriate for the installation location and materials.
- Do not install on gypsum board or concrete blocks.

## Installing the camera

- Attach the safety wire to the camera.
  - Place the ring of the safety wire (①) over the screw hole.
  - Place a washer (②) on top of the ring of the safety wire.
  - Tighten the screw (③) for the safety wire on top of the washer.

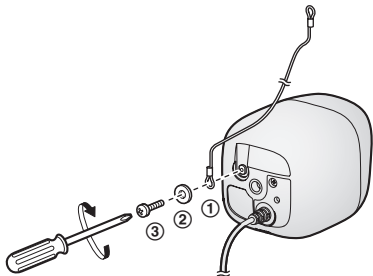

- Attach the camera mounting stand to an outdoor wall.
  - Secure the stand to the wall by tightening 4 screws (①).
  - A** 37 mm (1 15/32 inches)

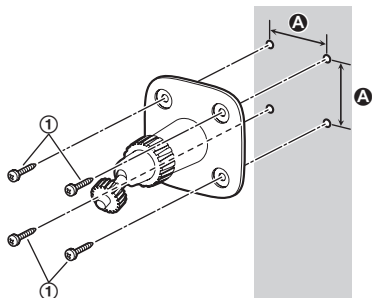

### Note:

- Use the following template below when determining the location of the screw holes.

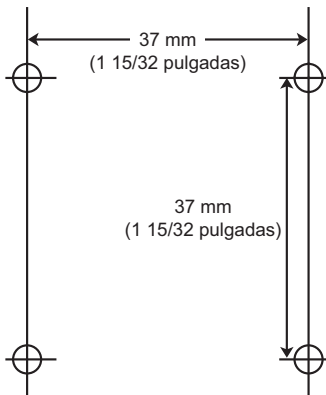

## Setup

- 3** Attach the camera to the stand.
- Loosen the screw (A).
  - Insert the tip of the stand (1) into the stand attachment hole (2) on the rear or bottom side.
  - Secure the camera by tightening the screw (B).

### Attaching to the hole on the rear side

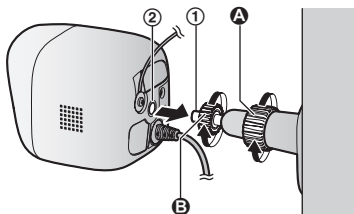

### Attaching to the hole on the bottom side

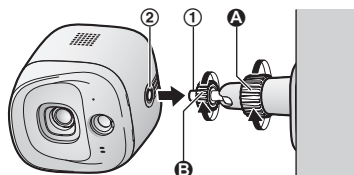

- 4** Adjust the camera angle.
- Loosen the screw (1), adjust the camera to the desired angle, and then tighten the screw (2) to secure the camera in place.

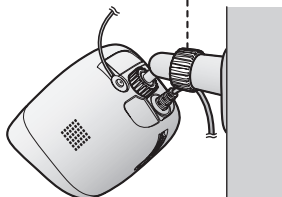
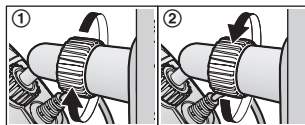

- 5** Attach the safety wire to the wall.
- Place the ring of the safety wire (①) on the wall.
  - Place the washer (②) on top of the ring of the safety wire.
  - Tighten the screw (③) for the safety wire on top of the washer.

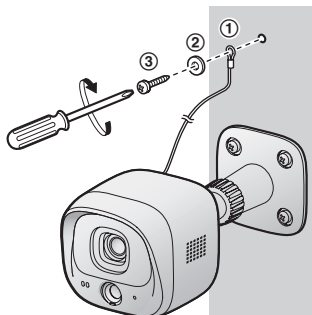
**Note:**

- Attach the safety wire while it is bent.
- Attach the safety wire high on the wall so that the camera does not strike anyone in the event the camera detaches from the wall.
- Do not hang from the camera or stand.

- 6** Connect the DC cable to the AC adaptor.
- Pull the DC cable indoors, and connect the DC cable plug (①) to the AC adaptor plug (②).
  - Connect the AC adaptor (③) to the power outlet.
- A** Outdoors  
**B** Indoors

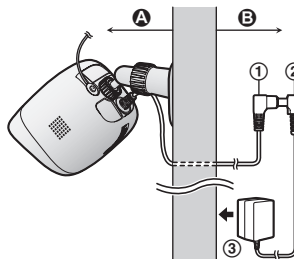
**Note:**

- Use only the supplied Panasonic AC adaptor PNLV236.
- Be sure to connect the DC cable plug and AC adaptor plug indoors.

**Note about power connections****AC adaptor connection**

- The AC adaptor must remain connected at all times. (It is normal for the adaptor to feel warm during use.)
- The AC adaptor should be connected to a vertically oriented or floor-mounted AC outlet. Do not connect the AC adaptor to a ceiling-mounted AC outlet, as the weight of the adaptor may cause it to become disconnected.

**Power failure**

- The camera will not work during a power failure.

### Testing the motion detection range

After you have installed the **[Home Network]** app on your mobile device, you can use your mobile device to test the performance of the camera's motion detection features.

For details about these operations, refer to the User's Guide (page 26).

- 1 Start the **[Home Network]** app and display live images from the camera.
- 2 Move to an area within the camera's viewable area.
- 3 While moving near the camera, use your mobile device to observe where you are in the viewable area when the camera's motion detection features are triggered.
  - When the motion detection features are triggered, the camera's LED indicator lights in red for about 3 seconds.
- 4 Note the areas of the viewable area where movement is detected, and make adjustments as necessary.

#### Note:

- You can adjust the area detectable by the visual sensor. For more information, refer to the User's Guide (page 26).
- You can adjust the area detectable by the infrared sensor. See "Adjusting the infrared sensor range", page 22.

### Testing the microphone

To test the microphone, speak loudly and clearly into the microphone while a mobile device user is viewing live images from the camera.







### Adjusting the infrared sensor range

If there are objects that you do not want the infrared sensor to detect, you can adjust the detectable area by attaching sensor range caps.

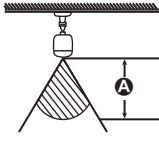
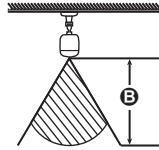
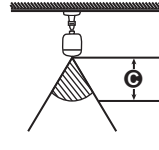
### Sensor range cap types and detectable area

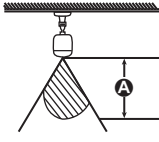
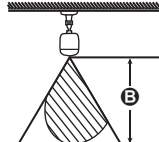
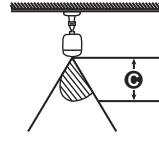
In addition to the standard cap (already attached to the camera), there are 4 cap types (cap 1-4). Each cap blocks different areas of the sensor range and can be attached at 45-degree increments. Refer to the following and attach the proper cap at the proper angle.

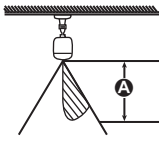
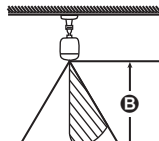
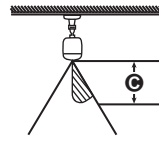
- The detectable areas shown here are an approximation for when the **[IR Sensor]** setting is set to **[Normal]**. For more information, refer to the User's Guide (page 26).
- The detectable area rotates according to the sensor range cap angle.

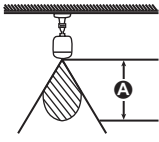
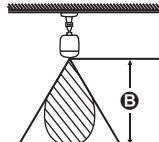
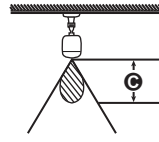
Situation and cap types	Approximate detection range (view when looking from above) *1		
	20 °C (68 °F)	0 °C (32 °F)	30 °C (86 °F)
<p>When you want both sides of the camera to be detectable</p> <p>Standard cap (attached to the camera)</p> 	 <p><b>A</b> 5 m (16.4 feet)</p>	 <p><b>B</b> 6 m (19.7 feet)</p>	 <p><b>C</b> 4 m (13.1 feet)</p>
<p>When you want one side to be undetectable</p> <p>Cap 1</p> 	<p>(Example) Cap 1</p>  <p><b>A</b> 5 m (16.4 feet)</p>	<p>(Example) Cap 1</p>  <p><b>B</b> 6 m (19.7 feet)</p>	<p>(Example) Cap 1</p>  <p><b>C</b> 4 m (13.1 feet)</p>
<p>Cap 2</p> 	<p>(Example) Cap 3</p>  <p><b>A</b> 5 m (16.4 feet)</p>	<p>(Example) Cap 3</p>  <p><b>B</b> 6 m (19.7 feet)</p>	<p>(Example) Cap 3</p>  <p><b>C</b> 4 m (13.1 feet)</p>
<p>Cap 3</p> 	<p>(Example) Cap 4</p>  <p><b>A</b> 5 m (16.4 feet)</p>	<p>(Example) Cap 4</p>  <p><b>B</b> 6 m (19.7 feet)</p>	<p>(Example) Cap 4</p>  <p><b>C</b> 4 m (13.1 feet)</p>

\*1 Varies by ambient temperature at the camera installation location. Numeric values are approximate. Detectable area is indicated by .

### About the attachment angle of the sensor range cap

#### Example 1

When there is an object on the right side of the viewable area that you do not want to be detected (such as trees):

Attach one of caps 1-3 as shown in the example (A) according to the area you do not want to be detected.

#### Example 2

When there is an object on the top left of the viewable area that you do not want to be detected (cars in a street, etc.):

Attach one of caps 1-3 as shown in the example (B) according to the area you do not want to be detected.

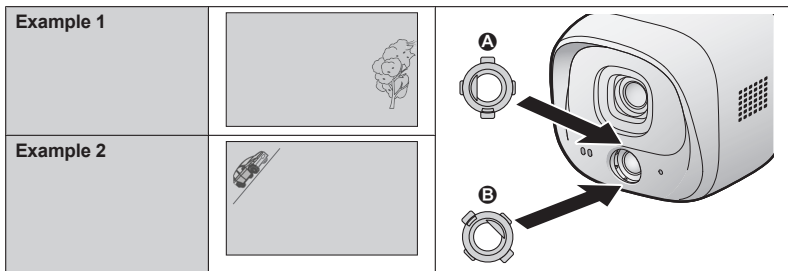



## Replacing sensor range caps

- 1 Remove the attached standard cap.

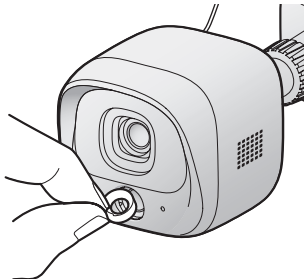

- 2 Remove the desired sensor range cap from one of the 4 types (①) and attach it to the sensor (②).

- When attaching, rotate the tab (A) on the cap toward the top or at a 45-degree angle according to the type of cap or direction, and attach the cap on the camera, shown in the following illustration.

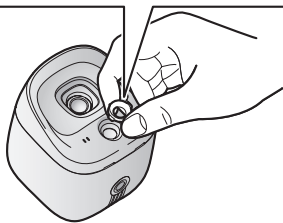
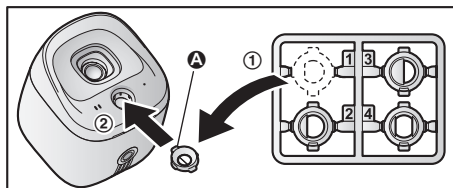



### Features available when using the [Home Network] app

Some of the camera's features that are available when using the [Home Network] app are listed below. For more information, refer to the User's Guide (page 26).

- **Security system**  
You can use the app to arm and disarm the security system, confirm the current status of the sensor, and view a log of previous security events.
- **Live camera monitoring**  
You can view live images from the camera, even while away from home.
- **Listen and talk**  
You can use your mobile device to talk and listen to anyone within range of the camera's microphone and speaker.
- **Sensor integration**  
You can configure the camera's sensor features to trigger other system events, such as camera recording\*1, turning on an electric device (such as a lamp), etc. (Appropriate device required.)  
\*1 A commercially-available microSD card must be inserted into the hub in order to record images.
- **Notification**  
You can configure the camera to send a notification to the [Home Network] app when the camera detect motion.

### Accessing the User's Guide

The User's Guide is a collection of online documentation that helps you get the most out of the [Home Network] app.

- 1 **iPhone®/iPad®**  
Tap  in the app's home screen.
- Android™ devices**  
Tap  or press your mobile device's menu button in the app's home screen.
- 2 Tap **[User's Guide]**.

**Note:**

- You can also access the User's Guide at the web page listed below.



[www.panasonic.net/pcc/support/tel/homenetwork/manual/](http://www.panasonic.net/pcc/support/tel/homenetwork/manual/)

## Specifications

- **Standards**  
DECT 6.0 (Digital Enhanced Cordless Telecommunications 6.0)
- **Frequency range**  
DECT: 1.92 GHz – 1.93 GHz
- **RF transmission power**  
DECT: 115 mW (max.)
- **Power source**  
120 V AC, 60 Hz
- **Power consumption**  
Standby: 1.4 W  
During operation:  
1.5 W (when the LED lights are not lit)  
2.3 W (when the LED lights are lit)
- **Operating conditions**  
-20 °C – 50 °C (-4 °F – 122°F)  
up to 90% relative humidity  
(non-condensing)
- **Transmitting range**  
Approx. 50 m (160 feet) indoors  
Approx. 300 m (1,000 feet) outdoors
- **Image sensor**  
0.3 megapixel CMOS
- **Minimum illuminance required**  
0 lx\*1
- **Focal length**  
Fixed (0.4 m (1.3 feet) – infinity)
- **Angular field of view (camera angle)**  
Horizontal: approx. 70°  
Vertical: approx. 50°
- **Motion detection method**  
Pyroelectric infrared sensor (PIR sensor) and visual sensor
- **PIR sensor detection range (when the surrounding temperature is approx. 25 °C (77 °F))**  
Horizontal: approx. 70°  
Vertical: approx. 20°  
Detection range: approx. 5 m
- **Visual sensor detection range**  
Horizontal: approx. 70°  
Vertical: approx. 50°
- **IP rating**  
IP55\*2
- **Adjustable mounting angles**  
Horizontal: ±90°  
Vertical: facing forward - facing down  
approx. 60°  
(adjustable when mounting)

- **Dimensions**

Approx. 75 mm × 75 mm × 173 mm (2 15/16 inches × 2 15/16 inches × 6 13/16 inches)

- **Mass (weight)**

Approx. 305 g (0.67 lb)

- \*1 The IR-LED will be lighted at the low illuminance conditions.
- \*2 Water resistance is only assured if the camera is installed correctly according to the instructions in the Installation Guide, and appropriate water protection measures are taken. Do not install the camera in areas directly exposed to water or rain.

### FCC and other information

This device complies with Part 15 of the FCC Rules. Operation is subject to the following two conditions:

(1) This device may not cause harmful interference, and (2) this device must accept any interference received, including interference that may cause undesired operation.

Privacy of communications may not be ensured when using this phone.

#### CAUTION:

Any changes or modifications not expressly approved by the party responsible for compliance could void the user's authority to operate this device.

#### NOTE:

This equipment has been tested and found to comply with the limits for a Class B digital device, pursuant to Part 15 of the FCC Rules. These limits are designed to provide reasonable protection against harmful interference in a residential installation. This equipment generates, uses, and can radiate radio frequency energy and, if not installed and used in accordance with the instructions, may cause harmful interference to radio communications. However, there is no guarantee that interference will not occur in a particular installation. If this equipment does cause harmful interference to radio or television reception, which can be determined by turning the equipment off and on, the user is encouraged to try to correct the interference by one or more of the following measures:

- Reorient or relocate the receiving antenna.
- Increase the separation between the equipment and receiver.
- Connect the equipment into an outlet on a circuit different from that to which the receiver is connected.
- Consult the dealer or an experienced radio/TV technician for help.

Some cordless telephones operate at frequencies that may cause interference to nearby TVs and VCRs. To minimize or prevent such interference, the base of the

cordless telephone should not be placed near or on top of a TV or VCR. If interference is experienced, move the cordless telephone further away from the TV or VCR. This will often reduce or eliminate interference.

#### FCC RF Exposure Warning:

- This product complies with FCC radiation exposure limits set forth for an uncontrolled environment.
- To comply with FCC RF exposure requirements, the device must be installed and operated 20 cm (8 inches) or more between the product and all person's body.
- This product may not be collocated or operated in conjunction with any other antenna or transmitter.
- For body-worn operation, the handset must be used only with a non-metallic accessory. Use of other accessories may not ensure compliance with FCC RF exposure requirements.

#### Notice:

- FCC ID can be found on the rear of the unit.

---

## Customer services

### ***Customer Services Directory (United States and Puerto Rico)***

Obtain Product Information and Operating Assistance; locate your nearest Dealer or Service Center; purchase Parts and Accessories; or make Customer Service and Literature requests by visiting our Web Site at:

**[www.panasonic.com/support](http://www.panasonic.com/support)**

or, contact us via the web at:

**[www.panasonic.com/contactinfo](http://www.panasonic.com/contactinfo)**

You may also contact us directly at: 1-800-211-PANA (1-800-211-7262),  
Monday - Friday 9 am to 9 pm; Saturday - Sunday 10 am to 7 pm, EST.

For hearing or speech impaired TTY users, TTY: 1-877-833-8855

### ***Accessory Purchases (United States and Puerto Rico)***

Purchase Parts, Accessories and Owner's Manual online for all Panasonic Products by visiting our Web Site at:

**[www.pstc.panasonic.com](http://www.pstc.panasonic.com)**

or, send your request by E-mail to:

**[npcparts@us.panasonic.com](mailto:npcparts@us.panasonic.com)**

You may also contact us directly at:

1-800-237-9080 (Fax Only)

(Monday - Friday 9 am to 9 pm, EST.)

Panasonic National Parts Center

20421 84th Avenue S., Kent, WA 98032

(We accept Visa, MasterCard, Discover Card, American Express.)

For hearing or speech impaired TTY users, TTY: 1-866-605-1277

## Warranty (For United States and Puerto Rico)

### Panasonic Home Network System Products Limited Warranty

#### Limited Warranty Coverage

If your product does not work properly because of a defect in materials or workmanship, Panasonic Corporation of North America (referred to as “the warrantor”) will, for the length of the period indicated on the chart below, which starts with the date of original purchase (“Limited Warranty period”), at its option either (a) repair your product with new or refurbished parts, or (b) replace it with a new or a refurbished equivalent value product, or (c) refund your purchase price. The decision to repair, replace or refund will be made by the warrantor.

	Parts	Labor
Home Network System Products	One (1) Year	One (1) Year
microSD card (Included model only)	90 days	N/A

During the “Labor” Limited Warranty period there will be no charge for labor. During the “Parts” Limited Warranty period, there will be no charge for parts. You must mail-in your product prepaid during the Limited Warranty period. This Limited Warranty excludes both parts and labor for batteries, antennas, and cosmetic parts (cabinet). This Limited Warranty only applies to products purchased and serviced in the United States or Puerto Rico. This Limited Warranty is extended only to the original purchaser and only covers products purchased as new.

#### Mail-In Service--Online

##### Online Repair Request

To submit a new repair request and for quick repair status visit our Web Site at [www.panasonic.com/repair](http://www.panasonic.com/repair)

When shipping the unit carefully pack in a padded shipping carton, include all accessories, and send it prepaid. Include a letter detailing the complaint, a return address and provide a day time phone number where you can be reached. P.O. Boxes are not acceptable. Keep the tracking number for your records. A copy of valid registered receipt is required under the 1 year parts and labor Limited Warranty.

For Limited Warranty service for headsets if a headset is included with this product please follow instructions above.

**IF REPAIR IS NEEDED DURING THE LIMITED WARRANTY PERIOD THE PURCHASER WILL BE REQUIRED TO FURNISH A SALES RECEIPT/PROOF OF PURCHASE INDICATING DATE OF PURCHASE, AMOUNT PAID AND PLACE OF PURCHASE. CUSTOMER WILL BE CHARGED FOR THE REPAIR OF ANY UNIT RECEIVED WITHOUT SUCH PROOF OF PURCHASE.**

### Limited Warranty Limits And Exclusions

This Limited Warranty ONLY COVERS failures due to defects in materials or workmanship, and DOES NOT COVER normal wear and tear or cosmetic damage. The Limited Warranty ALSO DOES NOT COVER damages which occurred in shipment, or failures which are caused by products not supplied by the warrantor, or failures which result from accidents, misuse, abuse, neglect, bug infestation, mishandling, misapplication, alteration, faulty installation, set-up adjustments, misadjustment of consumer controls, improper maintenance, power line surge, lightning damage, modification, introduction of sand, humidity or liquids, commercial use such as hotel, office, restaurant, or other business or rental use of the product, or service by anyone other than a Factory Service Center or other Authorized Servicer, or damage that is attributable to acts of God.

**THERE ARE NO EXPRESS WARRANTIES EXCEPT AS LISTED UNDER "LIMITED WARRANTY COVERAGE". THE WARRANTOR IS NOT LIABLE FOR INCIDENTAL OR CONSEQUENTIAL DAMAGES RESULTING FROM THE USE OF THIS PRODUCT, OR ARISING OUT OF ANY BREACH OF THIS LIMITED WARRANTY.** (As examples, this excludes damages for lost time, lost calls or messages, cost of having someone remove or re-install an installed unit if applicable, travel to and from the servicer. The items listed are not exclusive, but are for illustration only.) **ALL EXPRESS AND IMPLIED WARRANTIES, INCLUDING THE WARRANTY OF MERCHANTABILITY, ARE LIMITED TO THE PERIOD OF THE LIMITED WARRANTY.**

Some states do not allow the exclusion or limitation of incidental or consequential damages, or limitations on how long an implied warranty lasts, so the exclusions may not apply to you.

This Limited Warranty gives you specific legal rights and you may also have other rights which vary from state to state. If a problem with this product develops during or after the Limited Warranty period, you may contact your dealer or Service Center. If the problem is not handled to your satisfaction, then write to the warrantor's Consumer Affairs Department at the addresses listed for the warrantor.

**PARTS AND SERVICE, WHICH ARE NOT COVERED BY THIS LIMITED WARRANTY, ARE YOUR RESPONSIBILITY.**

#### When you ship the product

- Carefully pack your unit, preferably in the original carton.
- Attach a letter, detailing the symptom.
- Send the unit to Panasonic Exchange Center, prepaid and adequately insured.
- Do not send your unit to Panasonic Corporation of North America listed on the back cover or to executive or regional sales offices. These locations do not repair consumer products.

# IMPORTANT!

If your product is not working properly. . .

- ① **Reconnect the AC adaptor to the camera.**
- ② Use the **Home Network app** to access the **User's Guide** and refer to the **Troubleshooting** section.



Visit our Web site: [www.panasonic.com/support](http://www.panasonic.com/support)  
• FAQ and troubleshooting hints are available.

#### For your future reference

We recommend keeping a record of the following information to assist with any repair under warranty.

Serial No.	Date of purchase
(found on the rear of the unit)	
Name and address of dealer	

Attach your purchase receipt here.

Panasonic Corporation of North America  
Two Riverfront Plaza, Newark, NJ 07102-5490

© Panasonic System Networks Co., Ltd. 2014